

Product datasheet

Specifications



Low Harmonic Drive System ATV680 - 250/200kW - 400 V - IP23

ATV680C25Q4X1

Price: 1,189,865.56 ZAR

Main

Device Short Name	ATV680
Product Destination	Asynchronous motors Synchronous motors
Ip Degree Of Protection	IP23 conforming to IEC 61800-5-1
Supply Frequency	50/60 Hz +/- 5 %
Network Number Of Phases	3 phases
Range Of Product	Altivar Process ATV600
Product Or Component Type	Variable speed drive
Product Specific Application	Process and utilities
Communication Port Protocol	EtherNet/IP Modbus TCP Modbus serial
[Us] Rated Supply Voltage	380...415 V - 10...6 %
Motor Power Kw	250 kW for normal duty 200 kW for heavy duty

Complementary

Provided Equipment	Enclosure Spacial SF Graphical operating panel in the enclosure door Main switch Semiconductor fuses Clean power filter with EMC filter Active infeed converter module Frequency inverter Terminal block main supply Terminal block motor
Colour Of Enclosure	Light grey (RAL 7035)
Type Of Cooling	Forced convection
Output Voltage	<= power supply voltage
Permissible Temporary Current Boost	1.1 x In during 60 s (normal duty) 1.5 x In during 60 s (heavy duty)
Speed Drive Output Frequency	0.1...500 Hz
Speed Accuracy	V/f mode: slip frequency VC without feedback: 0.3 x slip frequency
Continuous Output Current	477 A at 2.5 kHz for normal duty 370 A at 2.5 kHz for heavy duty
Energy Efficiency Ratio	0.965

Excluding VAT and subject to change. Please check with your local distributor through "Where to buy"

Power Dissipation In W	9910 W, total (normal duty) 7870 W, total (heavy duty) 1160 W, control part (normal duty) 920 W, control part (heavy duty)
Volume Of Cooling Air	2320 m3/h for control 280 m3/h for power
Prospective Line Isc	50 kA for 100 ms
Motor Recommended Cable Cross Section	2 x (3 x 150 mm ²) (normal duty) 3 x (3 x 95 mm ²) (normal duty) 2 x (3 x 120 mm ²) (heavy duty) 3 x (3 x 70 mm ²) (heavy duty)
Height	2150 mm
Depth	664 mm
Safety Function	STO (safe torque off), level SIL 3 for <= 100 ms
Protection Type	Motor: thermal protection Motor: safe torque off Motor: motor phase break Drive: thermal protection Drive: safe torque off Drive: overheating Drive: overcurrent (between output phases and earth) Drive: overload (output) Drive: short-circuit protection Drive: motor phase break Drive: overvoltage (DC bus) Drive: line supply overvoltage Drive: line supply undervoltage Drive: line supply phase loss Drive: overspeed Drive: break on the control circuit Drive: short-circuit protection with semi-conductor fuse (main supply) Drive: fan monitoring
Frequency Resolution	Display unit: 0.1 Hz Analog input: 0.012/50 Hz
Connector Type	RJ45 (on the control block) for Modbus serial RJ45 (on the control block) for Ethernet IP/Modbus TCP
Physical Interface	2-wire RS 485 for Modbus serial
Transmission Frame	RTU for Modbus serial
Transmission Rate	10/100 Mbit/s for Ethernet IP/Modbus TCP 4.8, 9.6, 19.2, 38.4 kbit/s for Modbus serial
Exchange Mode	Half duplex, full duplex, autonegotiation Ethernet IP/Modbus TCP
Data Format	8 bits, configurable odd, even or no parity for Modbus serial
Type Of Polarization	No impedance for Modbus serial
Number Of Addresses	1...247 for Modbus serial
Supply	External supply for digital inputs: 24 V DC (19...30 V), <1.25 mA, protection type: overload and short-circuit protection Internal supply for reference potentiometer (1 to 10 kOhm): 10.5 V DC +/- 5 %, <10 mA, protection type: overload and short-circuit protection Internal supply for digital inputs and STO: 24 V DC (21...27 V), <200 mA, protection type: overload and short-circuit protection
Local Signalling	LCD display unit front door operation function, status and configuration
Input Compatibility	DI1...DI6: discrete input level 1 PLC conforming to EN/IEC 61131-2 DI5, DI6: discrete input level 1 PLC conforming to IEC 65A-68 STOA, STOB: discrete input level 1 PLC conforming to EN/IEC 61131-2
Discrete Input Logic	Positive logic (source) (DI1...DI6), < 5 V (state 0), > 11 V (state 1) Negative logic (sink) (DI1...DI6), > 16 V (state 0), < 10 V (state 1) Positive logic (source) (DI5, DI6), < 0.6 V (state 0), > 2.5 V (state 1) Positive logic (source) (STOA, STOB), < 5 V (state 0), > 11 V (state 1)

Sampling Duration	2 ms +/- 0.5 ms (DI1...DI4) - discrete input 5 ms +/- 1 ms (DI5, DI6) - discrete input 5 ms +/- 1 ms (AI1, AI2, AI3) - analog input 10 ms +/- 1 ms (AQ1, AQ2) - analog output
Accuracy	+/- 0.6 % AI1, AI2, AI3 for a temperature variation 60 °C analog input +/- 1 % AQ1, AQ2 for a temperature variation 60 °C analog output
Linearity Error	AI1, AI2, AI3: +/- 0.15 % of maximum value for analog input AQ1, AQ2: +/- 0.2 % for analog output
Refresh Time	Relay output (R1, R2, R3): 5 ms (+/- 0.5 ms)
Isolation	Between power and control terminals
Insulation Resistance	> 1 MOhm 500 V DC for 1 minute to earth
Relative Humidity	5...95 % without condensation conforming to IEC 60068-2-3
Option Card	Slot A: communication module, Profibus DP V1 Slot A: communication module, PROFINET Slot A: communication module, DeviceNet Slot A: communication module, Modbus TCP/EtherNet/IP Slot A: communication module, CANopen daisy chain RJ45 Slot A: communication module, CANopen SUB-D 9 Slot A: communication module, CANopen screw terminals Slot A/slot B: digital and analog I/O extension module Slot A/slot B: output relay extension module
Discrete Input Number	8
Discrete Input Type	DI1...DI6 programmable, 24 V DC (<= 30 V), impedance: 3.5 kOhm DI5, DI6 programmable as pulse input: 0...30 kHz, 24 V DC (<= 30 V) STOA, STOB safe torque off, 24 V DC (<= 30 V), impedance: > 2200 kOhm
Discrete Input Logic	16 preset speeds
Analogue Input Number	3
Analogue Input Type	AI1, AI2, AI3 software-configurable voltage: 0...10 V DC, impedance: 30 kOhm, resolution 12 bits AI1, AI2, AI3 software-configurable current: 0...20 mA, impedance: 250 Ohm, resolution 12 bits
Analogue Output Number	2
Analogue Output Type	Software-configurable voltage AQ1, AQ2: 0...10 V DC impedance 470 Ohm, resolution 10 bits Software-configurable current AQ1, AQ2: 0...20 mA, resolution 10 bits
Relay Output Number	3
Relay Output Type	Configurable relay logic R1: fault relay NO/NC electrical durability 100000 cycles Configurable relay logic R2: sequence relay NO electrical durability 100000 cycles Configurable relay logic R3: sequence relay NO electrical durability 100000 cycles
Maximum Switching Current	Relay output R1, R2, R3 on resistive load, cos phi = 1: 3 A at 250 V AC Relay output R1, R2, R3 on resistive load, cos phi = 1: 3 A at 30 V DC Relay output R1, R2, R3 on inductive load, cos phi = 0.4 and L/R = 7 ms: 2 A at 250 V AC Relay output R1, R2, R3 on inductive load, cos phi = 0.4 and L/R = 7 ms: 2 A at 30 V DC
Minimum Switching Current	Relay output R1, R2, R3: 5 mA at 24 V DC
Method Of Access	Slave Modbus TCP
Asynchronous Motor Control Profile	Variable torque standard Constant torque standard Optimized torque mode
Synchronous Motor Control Profile	Permanent magnet motor
Acceleration And Deceleration Ramps	S, U or customized Linear adjustable separately from 0.01 to 9000 s
Motor Slip Compensation	Adjustable Can be suppressed Not available in permanent magnet motor law Automatic whatever the load

Switching Frequency	2...8 kHz adjustable with derating factor
Nominal Switching Frequency	2.5 kHz
Braking To Standstill	By DC injection
Line Current	389 A at 400 V (normal duty) 313 A at 400 V (heavy duty)
Apparent Power	270 kVA at 400 V (normal duty) 217 kVA at 400 V (heavy duty)
Maximum Transient Current	525 A during 60 s per 10 min (normal duty) 555 A during 60 s per 10 min (heavy duty)
Short-Circuit Protection	Upstream: 500 A gG fuse (normal duty) Upstream: 400 A gG fuse (heavy duty) Internal: 315 A 2 aR fuse
Electrical Connection	Removable screw terminals, clamping capacity: 0.5...1.5 mm ² for control M12 bar for main supply M12 bar for motor
Cable Entry	Bottom
Width	1000 mm
Net Weight	700 kg

Environment

Noise Level	73 dB conforming to 86/188/EEC - physical agents (noise) directive
Emc Filter	Integrated conforming to EN/IEC 61800-3, category C3, shielded cable with 50 m Integrated conforming to EN/IEC 61800-3, category C4, unshielded cable with 80 m
Pollution Degree	2 conforming to EN/IEC 61800-5-1
Vibration Resistance	1.5 mm peak to peak (f= 3...10 Hz) conforming to IEC 60068-2-6 0.6 gn (f= 10...200 Hz) conforming to IEC 60068-2-6 3M3 conforming to IEC 60721-3-3
Shock Resistance	4 gn for 11 ms conforming to IEC 60068-2-27 3M2 conforming to IEC 60721-3-3
Operating Altitude	< 1000 m without derating 1000...2000 m with current derating 1 % per 100 m 2000...3800 m with current derating 1 % per 100 m for TT earthing system 2000...3800 m with current derating 1 % per 100 m for TN earthing system 2000...3800 m with current derating 1 % per 100 m for IT earthing system 3800...4800 m with current derating 1 % per 100 m for TT earthing system 3800...4800 m with current derating 1 % per 100 m for TN earthing system
Environmental Characteristic	Chemical pollution resistance class 3C3 conforming to EN/IEC 60721-3-3 Dust pollution resistance class 3S3 conforming to EN/IEC 60721-3-3 Humidity resistant class 3K3 conforming to EN/IEC 60721-3-3
Product Certifications	ATEX C-Tick EAC
Operating Position	Vertical +/- 10 degree
Marking	CE
Standards	EN/IEC 60204-1 EN/IEC 61800-2 EN/IEC 61800-3 EN/IEC 61800-5-1
Maximum Thdi	<5 % full load conforming to IEEE 519
Assembly Style	In floor-standing enclosure low harmonic version

Electromagnetic Compatibility	Electrostatic discharge immunity test level 3 conforming to IEC 61000-4-2 Radiated radio-frequency electromagnetic field immunity test level 3 conforming to IEC 61000-4-3 Electrical fast transient/burst immunity test level 4 conforming to IEC 61000-4-4 1.2/50 μ s - 8/20 μ s surge immunity test level 3 conforming to IEC 61000-4-5 Conducted radio-frequency immunity test level 3 conforming to IEC 61000-4-6
Overvoltage Category	III
Ambient Air Temperature For Operation	-10...0 °C without derating (with option enclosure heating) 0...40 °C without derating 40...50 °C with derating factor
Ambient Air Temperature For Storage	-25...70 °C

Packing Units

Unit Type Of Package 1	PCE
Number Of Units In Package 1	1
Package 1 Height	215 cm
Package 1 Width	66.9 cm
Package 1 Length	100 cm
Package 1 Weight	755 kg

Sustainability

Green Premium™ label is Schneider Electric's commitment to delivering products with best-in-class environmental performance. Green Premium promises compliance with the latest regulations, transparency on environmental impacts, as well as circular and low-CO₂ products.

Guide to assessing product sustainability is a white paper that clarifies global eco-label standards and how to interpret environmental declarations.

[Learn more about Green Premium >](#)

[Guide to assess a product's sustainability >](#)



Take-back

Resource performance

✓ Take-Back Program Available

Well-being performance

✓ Mercury Free

✓ Rohs Exemption Information Yes

Reach Regulation [REACH Declaration](#)

Eu Rohs Directive Pro-active compliance (Product out of EU RoHS legal scope)

China Rohs Regulation [China RoHS declaration](#)

Weee The product must be disposed on European Union markets following specific waste collection and never end up in rubbish bins

Dimensions Drawings

Dimensions

Right and Front Views

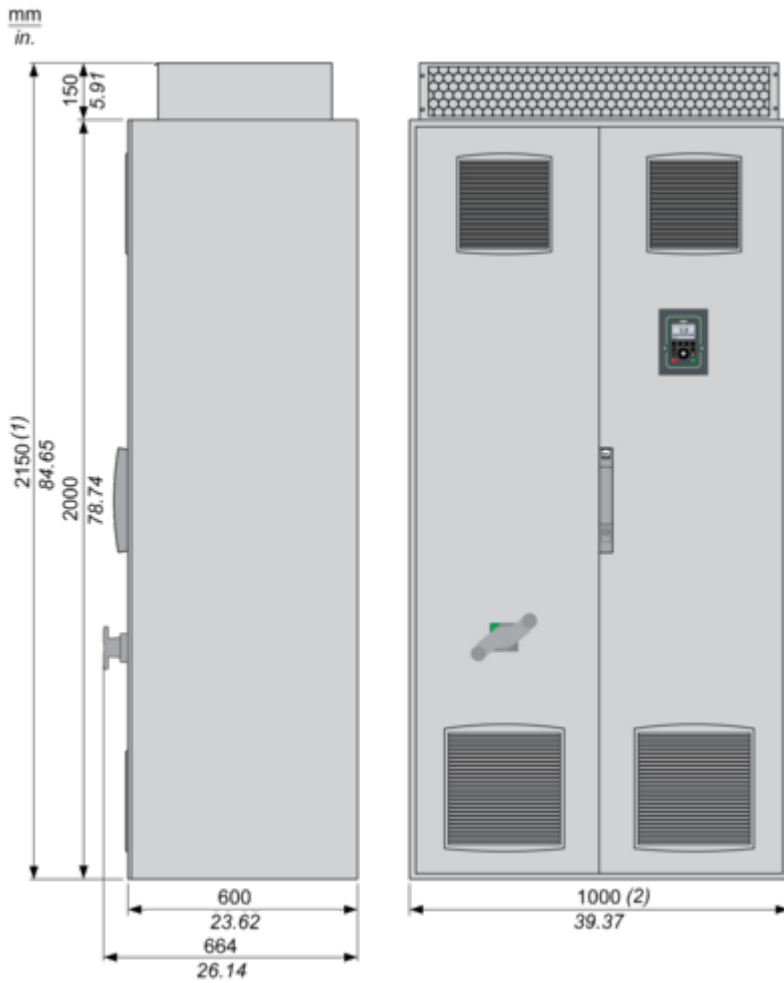

(1) + 200 mm/7.87 in. with option enclosure plinth or increased protection degree IP54.

(2) + 400 mm/15.74 in. with option connection enclosure cable from top/bottom.

Mounting and Clearance

Mounting and Clearance

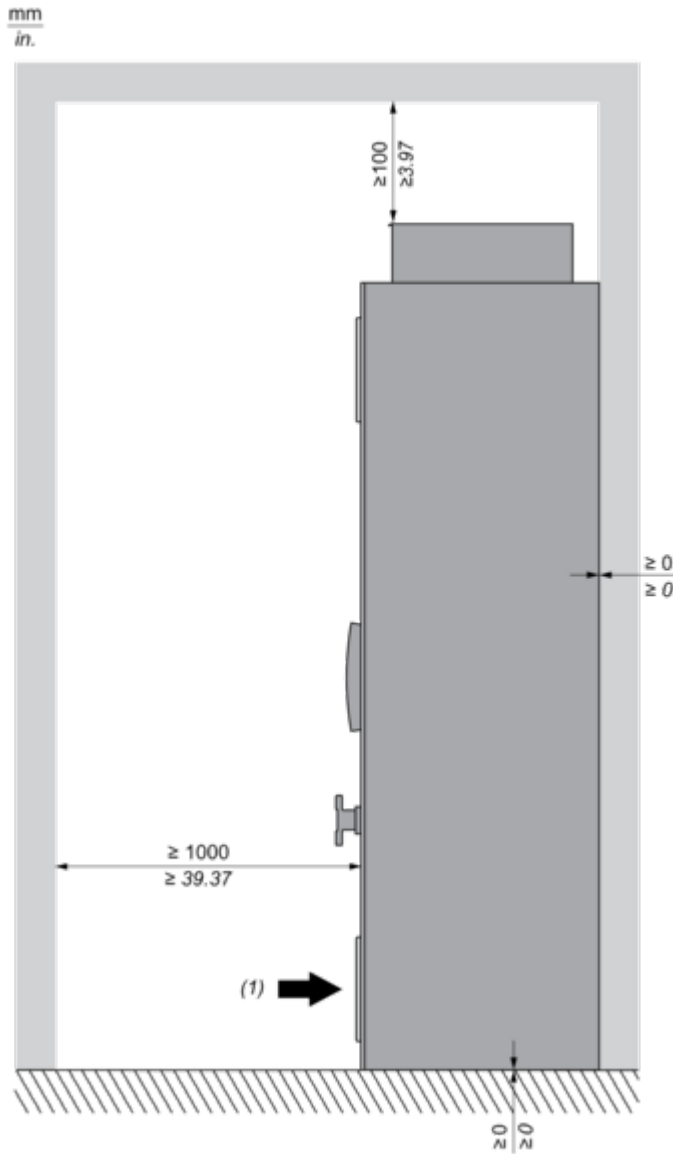

(1) Air inflow temperature: -10...+50 °C (below 0 °C with option enclosure heating, above +40 °C with derating).

Connections and Schema

Typical Wiring Diagram of the Frequency Inverter

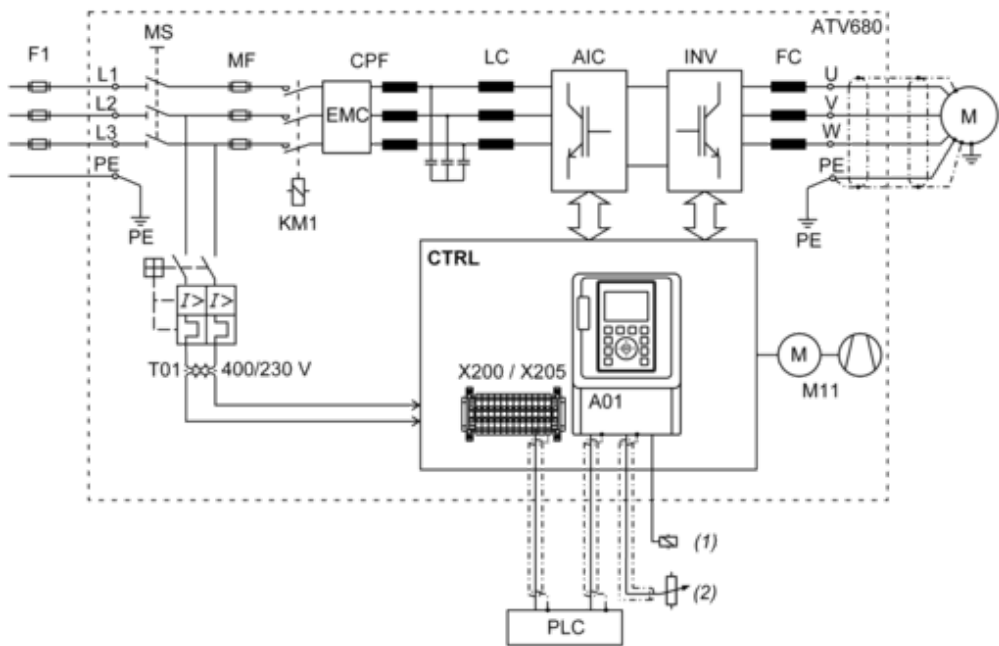

- F1** : External pre-fuse or circuit breaker
- MS** : Built-in main switch
- T01** : Control transformer 400 / 230 V AC
- MF** : aR fuses
- CPF** : Clean Power Filter with integrated EMC filter
- LC** : Line reactor Chokes
- AIC** : Active Infeed Converter module
- INV** : Inverter module
- FC** : dv/dt filter (from 200 kW the dv/dt filter choke 150 m is built-in as standard)
- CTRL** : Control panel
- A01** : Control terminals at the control block
- X200 / X205** : Control terminals at the control panel (depending on the chosen options)
- M11** : Fan in enclosure door
- KM1** : Line contactor
- (1) Relay control
- (2) Reference value

Structure of the Control Block

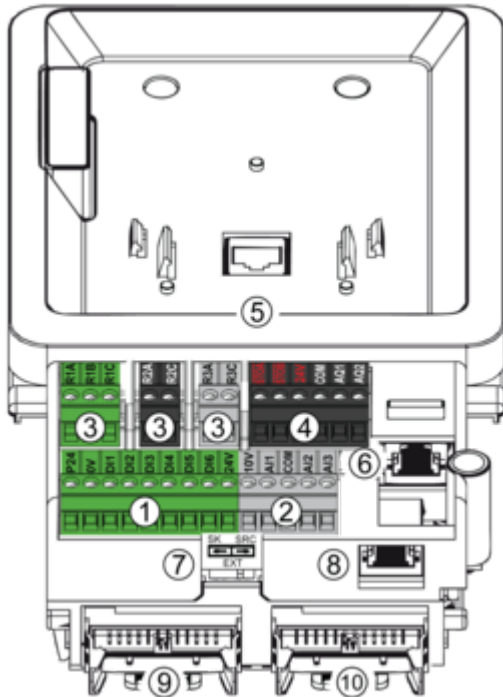

- (1) Digital inputs
- (2) Analog inputs
- (3) Relay outputs
- (4) STO (Safe Torque Off) and analog outputs
- (5) RJ45 port for door mounting kit of the graphic keypad
- (6) RJ45 port for Ethernet IP or Modbus TCP
- (7) Sink-Ext-Source selector switch (see switch configuration below)
- (8) RJ45 port for serial Modbus
- (9) Slot for I/O expansion card
- (10) Slot for fieldbus or I/O expansion card

Control Block Wiring Diagram



- (1) Safe Torque Off
- (2) Analog Output
- (3) Digital Input
- (4) Reference potentiometer
- (5) Analog Input
- R1A, R1B, R1C : Fault relay
- R2A, R2C : Sequence relay
- R3A, R3C : Sequence relay

Sensor Connection

It is possible to connect either 1 or 3 sensors on terminals AI2 or AI3.

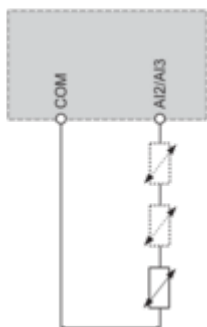

Sink / Source Switch Configuration

The switch is used to adapt the operation of the logic inputs to the technology of the programmable controller outputs.

- Set the switch to Source (factory setting) if using PLC outputs with PNP transistors.
- Set the switch to Ext if using PLC outputs with NPN transistors.

Switch Set to SRC (Source) Position Using the Output Power Supply for the Digital Inputs

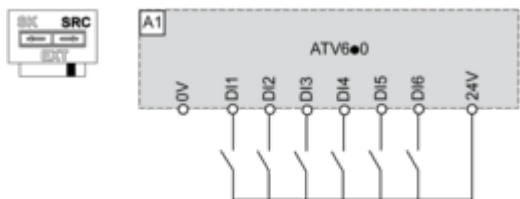

Switch Set to SRC (Source) Position and Use of an External Power Supply for the DIs

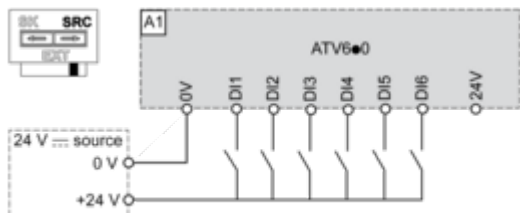

Switch Set to SK (Sink) Position Using the Output Power Supply for the Digital Inputs

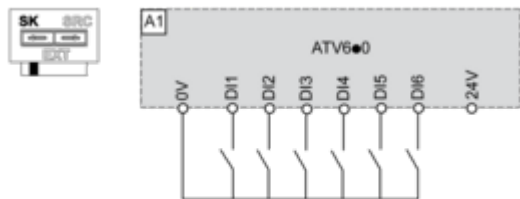

Switch Set to EXT Position Using an External Power Supply for the DIs

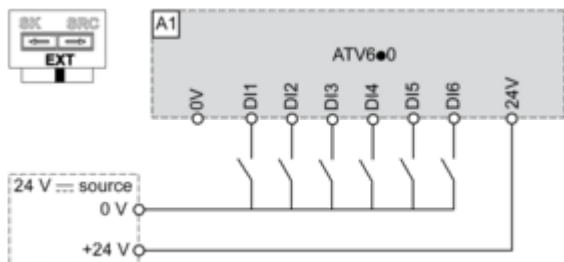

Performance Curves

Derating Curves

Normal Duty

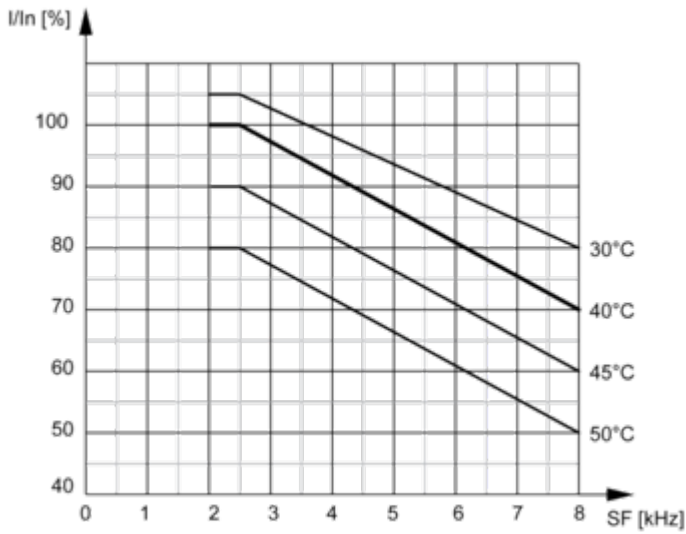

In : Nominal Drive Current
 SF : Switching Frequency

Heavy Duty

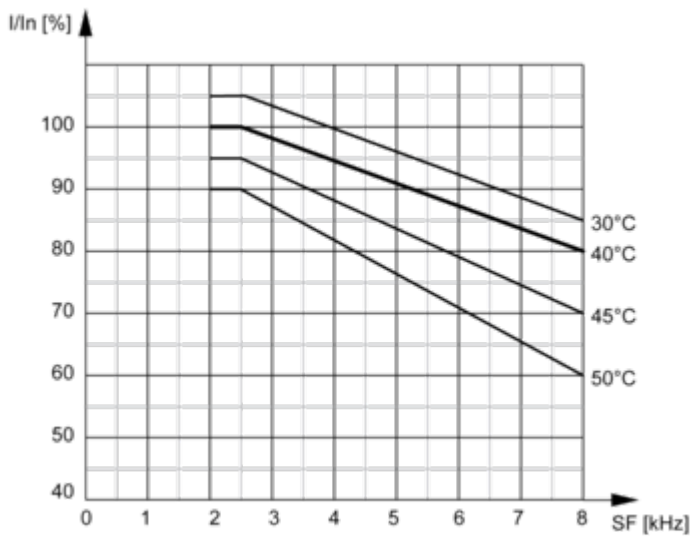

In : Nominal Drive Current
 SF : Switching Frequency